

SIMPLE SWADDLE BLANKET

Designed by Ramona Rose
www.ramonarose.net

Featuring *Cuddly Kittens* {flannel}



Finished project measures 40" x 40"

Pattern Level: Enthusiastic Novice





"I am a total beginner and want to learn more!"

ROBERT KAUFMAN
F A B R I C S

For questions about this pattern, please email Patterns@RobertKaufman.com.

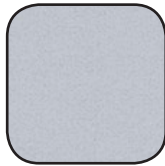
Fabric and Supplies Needed

Fabric amounts based on yardage that is 42" wide.

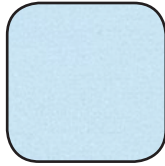
Color	Fabric	Name/SKU	Yardage	Color	Fabric	Name/SKU	Yardage
	A	AUNF-16979-10 PINK	1-1/4 yards		D	F019-959 DOLPHIN	1-1/4 yards
	B	F019-961 BUMBLE BEE	1-1/4 yards		E	AUNF-16978-4 BLUE	1-1/4 yards
	C	AUNF-16980-13 TAN	1-1/4 yards		F	F019-960 BLUE YONDER	1-1/4 yards
Copyright 2015, Robert Kaufman For individual use only - Not for resale							

Notes Before You Begin

- Please read through all of the instructions before beginning.
- All of the seam allowances are 1/4" unless otherwise noted.
- Press seam allowances open unless otherwise noted.
- Remember to measure twice and cut once!

Assembly Instructions

- Trim selvages from Fabrics A & B and cut each fabric into a square (depending on how generously you cut the selvages, you'll get a square about 40"-42" big).
- Place the two fabrics with right sides together, lining up all the sides, and pin the middle of each side to keep them from shifting.
- Find a small plate or bowl (the one used on the pictured blankets was 7" in diameter) and align it with a corner of the layered fabrics. Trace the curve. Trace curve of plate and cut off corner.
- Cut along the traced line, and then pin the curved edges together so the fabrics don't stretch or shift.
- Repeat for the three remaining corners.

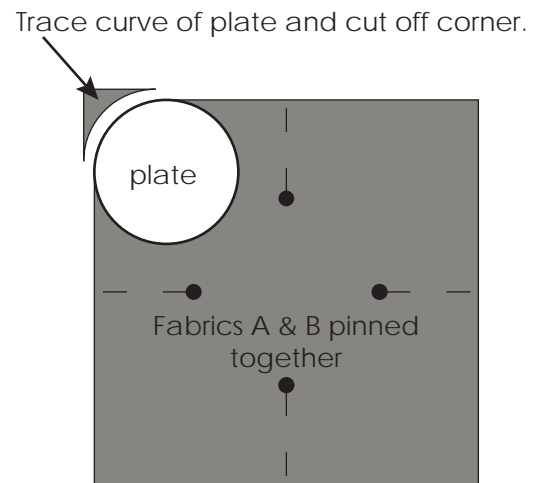

- Starting in the middle of one side, sew with a 1/4" seam allowance around the entire blanket, but stop about 4" before your starting point, backstitching at the beginning and end.

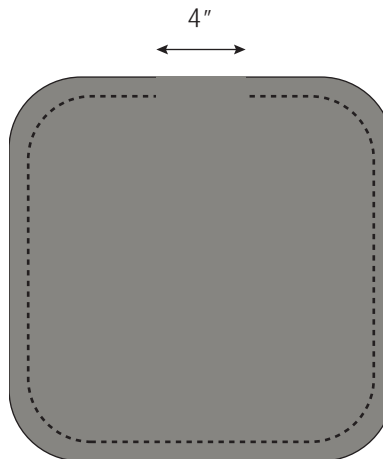

- Clip the curved seam allowances to help the blanket lay flat.
- Reach inside the blanket, and pull out the far corner, then ease out the rest of the blanket so it's right side out. Use your fingers to make sure the blanket is all the way out, and press the edges flat, using steam to press in 1/4" of the raw edges at the opening so you can hide it when you sew.
- Edgestitch all the way around the quilt close to the edge, closing the 4" opening as you sew.
- Repeat the above steps using Fabrics C & D to make a second blanket and Fabrics E & F to make a third.

Find a baby to swaddle in your adorable blankets!