

Flourishing Accents

designed by Heidi Pridemore for Robert Kaufman Fabrics



Holiday featuring
Flourish
by Peggy Toole



Tablecloth measures 55" x 55"



Tree Skirt measures 59" diameter

Uses just one fabric!
Fabric APTMX-10989 is 57" wide with a border printed on either side of the selvage, perfect for these and many other quick & easy projects!



ROBERTKAUFMAN
F A B R I C S
www.robertkaufman.com

Pattern will also include instructions for a rectangular tablecloth option & will be available to download free directly from Robert Kaufman Fabrics' website beginning April 2011

Holiday Flourish Round Tablecloth & Tree Skirt

Quilt designed by Heidi Pridemore

Approximate size 59" diameter or 80" diameter

All border strip length measurements are approximate.

Please measure your quilt top before cutting the length of each border.

| Fabric Requirements | 59" Diameter | 80" Diameter |
|-----------------------------------|--------------------------------------|--|
| Holiday Flourish | 3 yards | 7-1/2 yards |
| Bias Binding- | 1 yard of fabric for 6 yards binding | 2 yards of fabric for 10 yards of binding. |
| Backing (For the Tree Skirt Only) | 4 yards | 5-1/2 yards |

59" Diameter Cutting Instructions:

- 1) Cut the 3 yards of Holiday Flourish fabric in half lengthwise to create two 28-1/2" x 3 yard strips.
- 2) Starting on the upper left corner, measure and mark along the 3 yard border edge of on half of the fabric, into 23-1/2" increments (fig. 1).
- 3) Starting on the lower left corner measure and mark along the other 3 yard edge one 11-3/4" increment, then continue to measure and mark in 23-1/2" increments (fig. 2).
- 4) Draw a line from the upper left corner to the 11-3/4" mark. Draw a line from the 11-3/4" mark to the first 23-1/2" increment to make the first triangle for the tree skirt (fig. 3). Repeat to make four triangles with the border along the wide bottom of the triangle.
- 5) Repeat Steps 2-4 with the second 3 yard half of the Holiday Flourish fabric to cut four more triangles with the border on the wide bottom edge.

80" Diameter Cutting Instructions:

- 1) Cut the 57" wide fabric to measure 40" wide with the border running along the 7-1/2 yard edge.
- 2) Starting on the upper left corner, measure and mark along the 7-1/2 yard border edge, into 33" increments (fig. 1).
- 3) Starting on the lower left corner measure and mark along the other 7-1/2 yard edge one 16-1/2" increment, then continue to measure and mark in 33" increments (fig. 2).
- 4) Draw a line from the upper left corner to the 16-1/2" mark. Draw a line from the 16-1/2" mark to the first 33" increment to make the first triangle for the tree skirt (fig. 3). Repeat to make eight triangles with the border along the wide bottom of the triangle.

Tablecloth Assembly Instructions:

- 6) Sew together two triangles along the side edges, aligning the border print on both (fig. 4). Repeat to sew together four pairs of triangles. Press the pairs to one side.
- 7) Place one triangle pair on a cutting surface and use a square ruler to square up the triangle pair to have a 90° or Right angle (fig. 4). Repeat with the other three triangle pairs.
- 8) Sew together two triangle pairs to make one half of the octagon (fig. 5). Repeat to make the second half. Sew the two halves together to make the octagon (fig. 6). (IF MAKING THE TREE SKIRT, SKIP TO STEP 10.)
- 9) Turn the outer edge of the tablecloth under 1/2" then 1/2" again and press for the hem. Topstitch the hem to complete.

Tree Skirt Assembly Instructions:

- 10) Layer, quilt and bind the octagon as desired to make the tree skirt.
- 11) Trim the batting and backing to match the edges with the quilt top.
- 12) Trace the circle template onto the center of the octagon tree skirt. Cut up one sewn seam to the middle of the tree skirt and cut out the center on the drawn template line (fig. 7).
- 13) Use the bias binding to bind around the tree skirt.

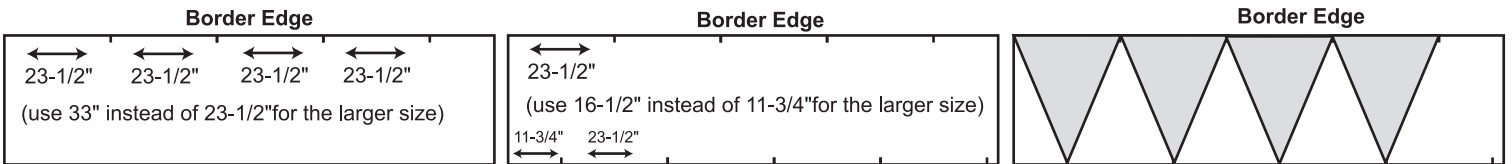

Fig. 1

Fig. 2

Fig. 3

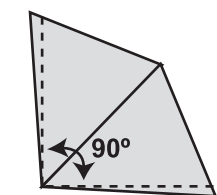

Fig. 4

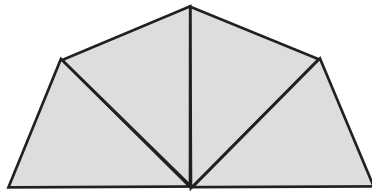

Fig. 5

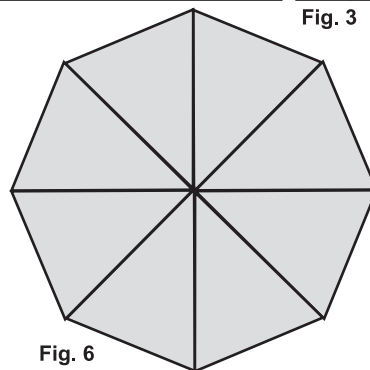

Fig. 6

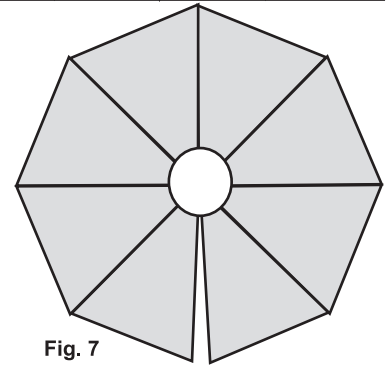

Fig. 7

Holiday Flourish Square & Rectangle Tablecloth

Quilt designed by Heidi Pridemore

Approximate size 55" square or 55" x desired length

All border strip length measurements are approximate. Please measure your quilt top before cutting the length of each border.

Fabric Requirements
Holiday Flourish

55" Square
3-1/4 yards

55" x Length of Choice
Desired Length + 57" = X, divide X by 36 = yardage
(ie. 72" + 57" = 129", 129 divided by 36 = 3.58 or 3-5/8 yards)

Table Cloth Instructions:

- 1) Cut two 57" pieces from the length of fabric (LOF) of the Holiday Flourish fabric (or 57" and the length of choice (LOC)) (Fig. 1).
- 2) Cut the 12" border from each the side of the two pieces of holiday flourish fabric (Fig. 2). You should now have four 12" x 57" border strips (or two 12" x 57" and two 12" x LOC strips) and two 33" x 57" center pieces (or one 33" x 57" and one 33" x LOC pieces). Discard one 33" x 57" piece. The remaining piece is the tablecloth center (33" x 57" for square or 33" x LOC for rectangle).
- 3) Cut 24" from the width of fabric of the tablecloth center leaving 33" x 33" for the square (Fig. 3).
- 4) Center one 12" x 57" Border strip on one side of the tablecloth center. Start sewing the strip a 1/4" away from the top edge of the quilt top and stop a 1/4" from the bottom edge. DO NOT TRIM THE EXCESS.
- 5) Repeat with the remaining three sides, making sure to stop and start 1/4" away from each end of the tablecloth center.
- 6) To miter each corner, fold the tablecloth center on a diagonal back sides together This should line up the strips from adjacent sides (Fig. 4).
- 7) Starting at the sewn seam (represented by the arrow in Figure 4) draw a 45° line out to the edge of the fabric. Sew on the drawn line. Trim the excess fabric leaving a 1/4" seam. Repeat this step with the remaining corners.
- 8) Turn the outer edge of the tablecloth under 1/2" then 1/2" again and press for the hem. Topstitch the side hems first then the top and bottom hems to complete the tablecloth.

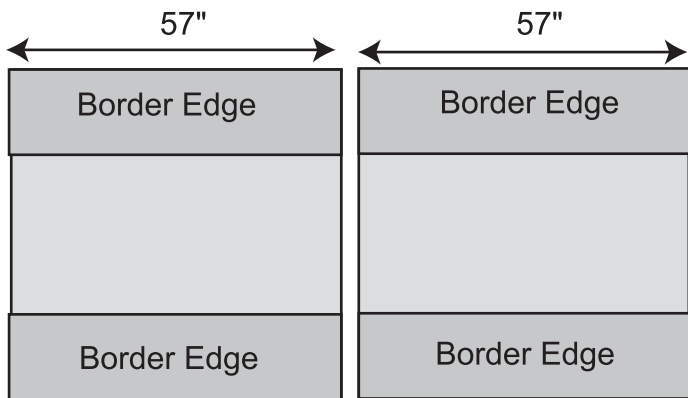

Fig. 1

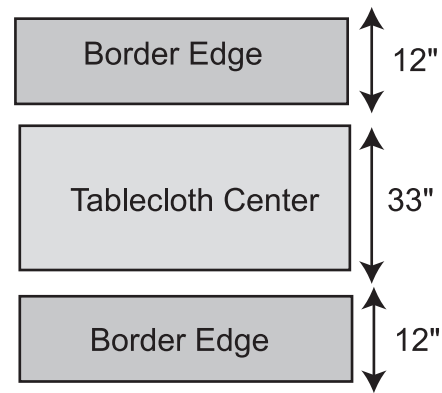

Fig. 2

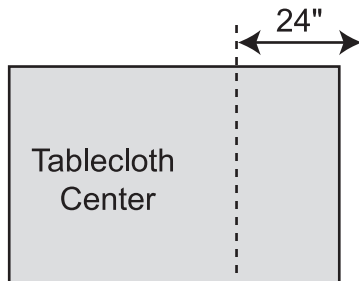

Fig. 3

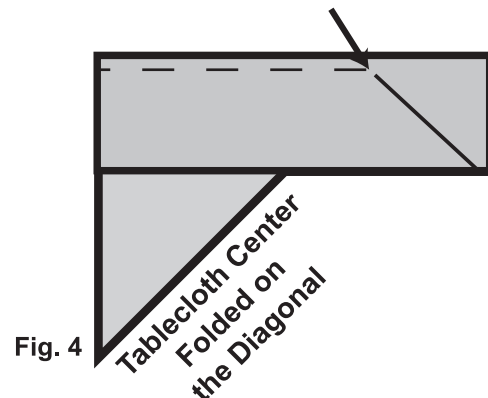

Fig. 4